

# INDIGOVISION HD INTERCEPTOR CAMERA WITH ILLUMINATION HINGE MOUNT QUICK START GUIDE

## PACKAGE CONTENTS

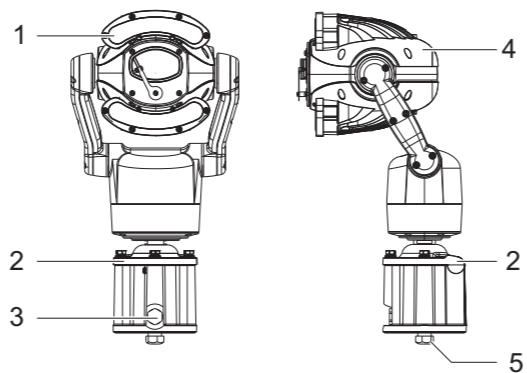

### Camera



1. IR light source
2. Hinged mount
3. Side access hole
4. Camera
5. Base access hole

### Additional items



- 4 x bolts
- Seal

## SAFETY NOTICES

### Warning

-  Ensure the power supply is switched off during installation.
-  When installing the camera, fasten it securely to the surface. A falling camera may cause personal injury.

### Caution

-  Only install in suitable environments.
  - ▶ For more information, see the User Guide.
-  Handle the camera with care so the main electronics and components are not damaged.
-  For security reasons, you must change the camera's default username and password.

### Notices

- Read this guide before installing the camera.
- The accessory PSU is IP65 rated (water jets) and must not be immersed under water.
- When the PSU is installed outdoors, waterproof cable joiners must be used to connect the PSU cables to the camera and the mains power source.



Document ID: IU-PTZ-MAN029-3

## CONNECTIONS

All variants that use the hinged mount have connections on the base of the camera.

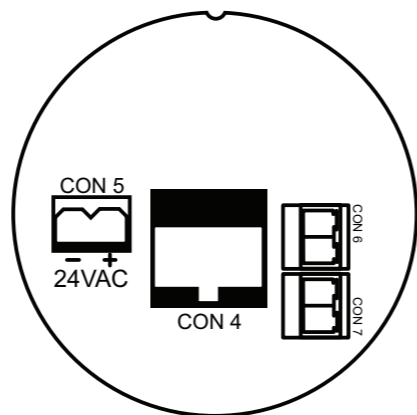

### Cable connections

Connector Number	Description	Signal
CON 4	Ethernet socket	RJ45
CON 5	Power supply, Black	AC/DC PSU -
CON 5	Power supply, Red	AC/DC PSU +
CON 6	Output COM	COM
CON 6	Output normally open	Normally open
CON 7	Not used	

## REGULATORY

- EN 55022 Class A
- EN 61000-3-2
- EN 61000-3-3
- FCC Part 15 Subpart B Class A
- EN 50130-4
- EN61000-4-2
- EN61000-4-3
- EN61000-4-4
- EN61000-4-5
- EN 61000-4-6
- EN61000-4-11
- IEC60068-2-27 (Shock)
- IEC60068-2-6 (Sine Vibration)
- IP68/IK10



COPYRIGHT © INDIGOVISION LIMITED. ALL RIGHTS RESERVED.

INDIGOVISION IS A TRADEMARK OF INDIGOVISION LIMITED AND IS REGISTERED IN CERTAIN COUNTRIES. SMS4, CAMERA GATEWAY, AND MOBILE CENTER ARE UNREGISTERED TRADEMARKS OF INDIGOVISION LIMITED. ALL OTHER PRODUCT NAMES REFERRED TO IN THIS MANUAL ARE TRADEMARKS OF THEIR RESPECTIVE OWNERS.

THIS MANUAL IS PROVIDED WITHOUT EXPRESS REPRESENTATION AND/OR WARRANTY OF ANY KIND.

PLEASE CONTACT INDIGOVISION LIMITED (EITHER BY POST OR BY E-MAIL AT PARTNER.SUPPORT@INDIGOVISION.COM) WITH ANY SUGGESTED CORRECTIONS AND/OR IMPROVEMENTS TO THIS MANUAL.

#### CONTACT ADDRESS

CHARLES DARWIN HOUSE,  
EDINBURGH TECHNOPOLE,  
EDINBURGH, EH26 0PY, UK

#### FURTHER INFORMATION

TO VIEW THIS GUIDE ONLINE, FOLLOW THIS LINK:  
[WWW.INDIGOVISION.COM/HDINTERCEPTOR-USERGUIDE](http://WWW.INDIGOVISION.COM/HDINTERCEPTOR-USERGUIDE)  
ALTERNATIVELY, SCAN THE QR CODE BELOW.



## 1. POWERING UP THE CAMERA

Auxiliary power requirements:

- HD Interceptor Camera with IR150W lighting: 24V AC +/- 10% 125VA Max
- HD Interceptor Camera with IR175 lighting: 24V AC +/- 10% 155VA Max

An optional power supply is available.



*Only use a Class 2 Isolated power supply for the AC/DC power input.*

All variants that use the hinged mount are powered using auxiliary power connections from separate power cables.

## 2. CONFIGURING THE DEVICE

### Initial IP properties

Initial Configuration	
Default Username	Admin
Default Password	1234
IP Address	10.5.1.10
Subnet Mask	255.0.0.0
Default Gateway	10.0.0.1

### Prepare an isolated network

Connect your device and the PC you are using to configure it on their own isolated network.

To do this, connect the device to the PC using an Ethernet cross-over cable.

### Preparing for initial device configuration

You cannot connect the device to your network until you have changed the IP settings to suit your network.

To change the factory defaults of your device, you must first, temporarily, modify your PC's network settings.



*Make a note of the original value of all settings that are to be changed so that you can re-enter them when you have completed the initial device configuration.*

### Configure your device

1. Open the Internet Explorer application.
2. Enter the factory default IP address into the browser address bar, then click **OK**.  
Default: 10.5.1.10
3. Click **Network** on the left of the page.  
The **Network** page opens.
4. Configure the settings to suit your installation.

#### Notice

*IndigoVision recommends that if you are using DHCP, you should configure the DHCP server to assign a given IP address based on the device's MAC address. Also, if the device does not receive any response from the DHCP server it will default to using the network parameters supplied by the last completed DHCP request.*



*Ensure that no two devices share the same IP address (or that of the PC).*

## 3. INSTALLATION



*When handling the camera with its cable fitted, support the camera body. Do not hold the camera by the cable bundle.*

1. Fit the seal (supplied) to the hinged mount.
2. Remove the three locking bolts and open the hinged mount. Ensure the safety cable is attached to the camera and hinged mount.
3. Run the cable through an M20 conduit then into the camera using the side or bottom entry hole.

The conduit must be sealed. If the cable is brought in using the bottom entry hole and there is a weather proof environment below the mounting surface, then the conduit is not required.

Use CAT5 cable for the Ethernet and a 2-core 14 AWG to 18 AWG cable for the power.

The maximum cable length for the CAT5 cable is 100m.

The maximum cable length for the camera power depends on the gauge.

- 14 AWG - 75m for IR175, 90m for IR150W
  - 16 AWG - 50m for IR175, 60m for IR150W
  - 18 AWG - 30m for IR175, 35m for IR150W
4. Connect the RJ45 connector to the camera (CON 4).
  5. Connect the power supply (CON 5).
  6. Close the hinge and secure the locking bolts.
  7. Tighten the conduit to ensure a water-tight seal around the cable.

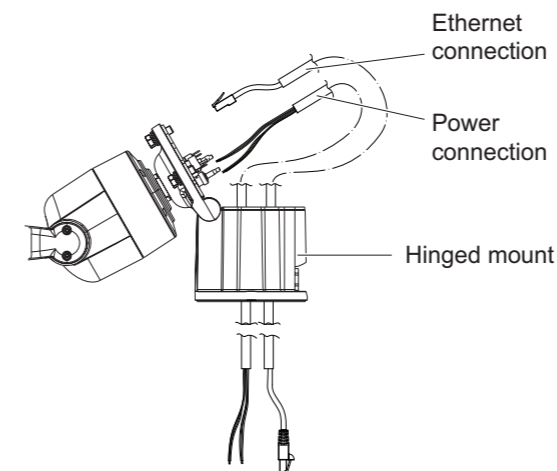

**Figure 1** Feed cable through the side or bottom entry holes of hinged mount

Do not use an adhesive or silicone between the seal and the surface that the hinged mount is attached to as this may trap moisture and affect the reliability of the product.



*When the optional sunshield is fitted to a camera it is necessary to set the Sunshield parameter to **ON**. This sets the tilt-up limit so that the camera does not hit the sunshield.*

► For more information on using the Web Configuration pages, refer to the User Guide.

### Reset the default factory settings

If there is a conflict with the camera's allocated IP address and another IP address on your network you may have to reset the camera back to the default factory settings, including all network connection settings.

1. Disconnect the camera from your network.
2. Power off the camera for three seconds.
3. Power on the camera for four seconds.
4. Repeat step two and three for five times.
5. On the final power on leave the power switched on for at least five minutes to allow the camera to initialise.